



Create happiness for  
your business life

# PROMOTIONAL SHOWCASE

青岛科博制冷设备有限公司  
QINGDAO CLABO EASYBEST REFRIGERATION EQUIPMENT CO.,LTD.

TEL: +86-532-55677991  
Free Service Call  
400-069-6799

Service Hotline: +86-15969849257  
E-mail: [info@qdeasybest.com](mailto:info@qdeasybest.com)  
[Http://www.qdeasybest.com](http://www.qdeasybest.com)  
[Http://easybest.cn.1688.com](http://easybest.cn.1688.com)

No.2 Ronghai Road  
Jihongtan Street Chengyang  
District, Qingdao Shandong  
China 266109



EasyBest官网



EasyBest客户之家

2017 版 Version

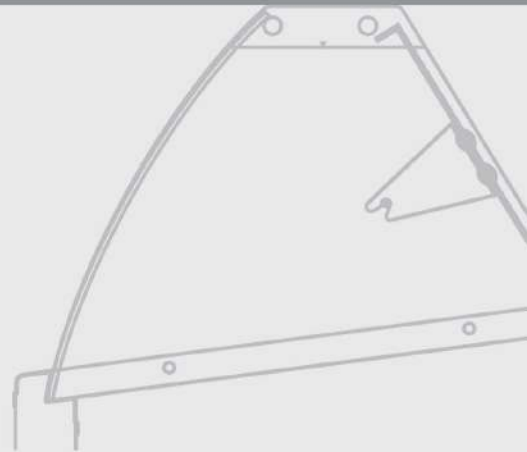

意大利技术  
Italian Technology

# Ingenuity

匠心独具

青岛科博制冷设备有限公司，一个富有活力的意大利工业实体，始创于2005年，2013年正式进军中国市场，致力于意大利冰淇淋展示柜及蛋糕展示柜的研发与生产，时刻准备着为每一位拥有甜蜜梦想的伙伴提供专属您的解决方案。

我公司产品采用意大利先进的制冷技术，意大利优质的制冷配件及意大利时尚的外观设计，所有产品均按照国际标准生产，我们先后通过了CE认证、KC认证、CCC认证、ROSH认证，美国及加拿大ETL、ETL SANITATION及ISO9001等产品与企业认证，并且取得30多项外观设计专利，这为我们开拓欧洲、东南亚、南美、北美等国际市场以及国内市场奠定了坚实的基础。

针对中国市场，为您提供以下专属服务：

- 风格独特的店面设计及开店解决方案
- 彰显个性的展示柜外观颜色及LOGO定制
- 24个月免费的专业售后服务

用敏锐的目光去洞察市场的需求，以优质的产品，稳定的质量，周到的服务满足顾客的崇高需求，是我们的生存理念，也是我们不懈的追求。在科技迅猛发展的今天，我们将带您领略全新的生活方式。EasyBest，一个充满活力的企业愿与您共创美好未来！

Qingdao Clabo Easy Best Refrigeration Equipment Ltd., a dynamic Italian-founded company, set up in 2005 and in 2013 entered Chinese market. We are devoted to the research and development of equipment of Gelato and sorrittado and well-prepared to provide exclusive solution to every partner with dessert dreams.

Adopted Italian advanced refrigerating technology, quality components and modern appearance design, all products are produced in complying with international standards, and approved by CE, CCC and ROHS, ETL, ETL SANITATION of US and Canada and ISO9001. We boasts over 30 appearance patents. All of these provide sound foundation for exploring domestic and international markets including Europe, Southeast Asia, South and North America.

With respect to features of Chinese market, we offer the exclusive services as follows:

- Store design with unique features and solution for opening new stores;
- Personalized show case with customized LOGO;
- 24 months free after-sale service

We are pursuing quality products, consistent quality and considerate service while be keen to market demand. With ever-changing science and technology, we, paying equal emphasis on preciseness and romance, will offer you a brand new lifestyle. EasyBest, a company full of vigor and vitality, is happy to join hands with you to a bright future.





- Ventilated 风冷
- Auto Defrosting 自动化霜
- Refrigerant R404A 制冷剂 R404A
- Opening Glass 玻璃开启方式
- Temperature 工作温度 -18~-18°C
- Climatic class°C, RH% 环境温度/湿度 30/60

1. Hermetic compressor: High refrigerating capacity, low consumption and low noise.
2. Automatic inversion cycle defrost: quick, complete, Low temperature fluctuations.
3. Full intelligence thermostat: Italy brand Dixell thermostat, all-round monitoring temperature, safe and convenient.
4. Vacuum tempered glass s with heater: safe, defrost automatically, perfect display affection and suitable for high humidity area.
- 5.Barrel stent can be configured in this showcase.
- 6.LED environmental lamp system: aesthetics, energy-saving, durability.
- 7.Customized logo and color: Highlight the brand image, different from others.
- 8.With wheels and feet: easy to move and fix.

1. 全封闭进口制冷压缩机：高效、低耗、低噪音。
2. 全自动逆循环化霜系统：迅速、干净、柜内温度波动低。
3. 全智能温控体系：意大利DIXELL超智能温控器，全天候全方位监控柜内温度、安全、省心。
4. 双层中空电加热防雾玻璃：全钢化、不起雾、透光性强、耐温度高。
5. 该款产品可做成圆槽配置。
- 6.LED环保照明系统：美观、节能、耐用。
- 7.品牌私人订制LOGO及颜色：突显品牌形象、与众不同。
- 8.轮子拖脚双配置：方便移动与位置固定。

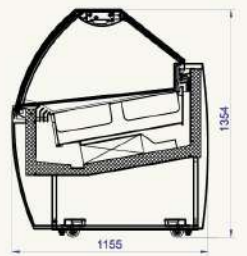

PANS MODEL / 份数盘		12	16	18	20
		8	10	12	12



MODEL 型号	Dimensions : LxWxH ( mm ) 尺寸：长*宽*高 ( mm )	Weight(net / gross)(Kg) 净重/毛重 ( Kg )	Voltage V/ph/Hz 电源 V/ph/Hz	Input power(W) 输入功率(W)
12	1282*1155*1354	230/285	220-240/1/50	1400
16	1612*1155*1354	285/345	220-240/1/50	1600
18	1777*1155*1354	302/415	220-240/1/50	1750
20	1942*1155*1354	347/517	400/3/50	2700
24	2272*1155*1354	379/569	400/3/50	2750



- Ventilated 风冷
- Defrosting 自动化霜
- Refrigerant R404A 制冷剂 R404A
- Temperature 工作温度 -16~-18℃
- Climatic class°C/RH% 环境温度/湿度 30/60

1. Hermetic compressor: High refrigerating capacity, low consumption and low noise.
2. Automatic inversion cycle defrost: quick, complete, Low temperature fluctuations.
3. Full intelligence thermostat: Italy brand Dixell thermostat, all-round monitoring temperature, safe and convenient.
4. Vacuum tempered glass s with heater: safe, defrost automatically, perfect display affection and suitable for high humidity area.
5. LED environmental lamp system: aesthetics, energy-saving, durability.
6. Customized logo and color: Highlight the brand image, different from others.
7. With wheels and feet: easy to move and fix.

1. 全封闭进口制冷压缩机: 高效、低耗、低噪音。
2. 全自动逆循环化霜系统: 迅速、干净、柜内湿度波动低。
3. 全智能温控体系: 意大利DIXELL超智能温控器, 全天候全方位监控柜内温度, 安全、省心。
4. 双层中空电加热防雾玻璃: 全钢化、不起雾、透视性强、耐温度高。
5. LED环保照明系统: 美观、节能、耐用。
6. 品牌私人订制LOGO及颜色: 突显品牌形象、与众不同。
7. 轮子底座双配置: 方便移动与位置固定。

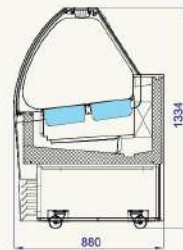

PANIS MODEL / 份数盘	10	12
 PANIS 10, 300x307x100mm (20x15)	10	12
 PANIS 7, 150x307x100mm (15x15)	7	9
 PANIS 7, 300x307x100mm	7	9

ENERGY



MODEL 型号	Dimensions :LxWxH (mm) 尺寸:长*宽*高 (mm)	Weight(net/gross)(Kg) 净重/毛重 (Kg)	Voltage V/ph/Hz 电源 V/ph/Hz	Input power (W) 输入功率 (W)
10	1034*880*1334	170/220	220-240/1/50	1150
12	1234*880*1334	200/250	220-240/1/50	1300





- Ventilated  
风冷
- Defrosting  
自动化霜
- Refrigerant R404A  
制冷剂 R404A
- Temperature  
工作温度 -16~-18℃
- Climatic class°C/RH%  
环境温度/湿度 30/60

1. Hermetic compressor: High refrigerating capacity, low consumption and low noise.
2. Automatic inversion cycle defrost: quick, complete. Low temperature fluctuations.
3. Full intelligence thermostat: Italy brand Dixell thermostat, all-round monitoring temperature, safe and convenient.
4. Vacuum tempered glass s with heater: safe, defrost automatically, perfect display affection and suitable for high humidity area.
5. Straight glass, fashion and adapt for any furniture.
6. LED environmental lamp system: aesthetics, energy-saving, durability.
7. Customized logo and color: Highlight the brand image, different from others.
8. With wheels and feet: easy to move and fix.

1. 全封闭进口制冷压缩机：高效、低耗、低噪音。
2. 全自动逆循环化霜系统：迅速、干净、柜内温度波动低。
3. 全智能温控体系：意大利DIXELL超智能温控器，全天候全方位监控柜内温度、安全、省心。
4. 双层中空钢化防雾玻璃：全钢化、不起雾、透视力强、耐湿度高。
5. 直玻璃外观设计：时尚前卫、与吧台契合度高。
6. LED环保照明系统：美观、节能、耐用。
7. 品牌私人订制LOGO及颜色：突显品牌形象、与众不同。
8. 轮子底部双配置：方便移动与位置固定。

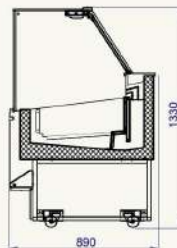

PANS MODEL / 份数盘	10	12
 PANA 236 300*300*100MM 30*10	10	12
 PANA 236 300*180*100MM 18*10	7	9
 PANA 236 300*180*100MM	7	9

ENERGY FG



MODEL 型号	Dimensions: LxWxH (mm) 尺寸:长*宽*高 (mm)	Weight(net/gross)(Kg) 净重/毛重 (Kg)	Voltage V/ph/Hz 电压 V/ph/Hz	Input power (W) 输入功率 (W)
10	1070*890*1330	170/220	220-240/1/50	1150
12	1270*890*1330	200/250	220-240/1/50	1300



- Ventilated 风冷
- Auto Defrosting 自动化霜
- Refrigerant R404A 制冷剂 R404A
- Temperature 工作温度 -16~-18°C
- Climatic class°C/RH% 环境温度/湿度 30/75



1. Hermetic compressor: High refrigerating capacity, low consumption and low noise.
2. Automatic inversion cycle defrost: quick, complete, Low temperature fluctuations.
3. Full intelligence thermostat: Italy brand Dixell thermostat, all-round monitoring temperature, safe and convenient.
4. Vacuum tempered glass with heater: safe, defrost automatically, perfect display affection and suitable for high humidity area.
5. Straight Front glass for the best visibility.
6. LED environmental lamp system: aesthetics, energy-saving, durability.
7. Customized logo and color: Highlight the brand image, different from others.
8. With wheels and feet: easy to move and fix.

1. 全封闭进口制冷压缩机：高效、低耗、低噪音。
2. 全自动逆循环霜系统：迅速、干净、柜内温度波动低。
3. 全智能温控系统：意大利DIXELL超智能温控器，全天候全方位监控柜内温度。安全、省心。
4. 双层中空电加热的雾玻璃：全钢化、不起雾、透视力强、耐湿度高。
5. 平板式前玻璃使产品有更好的展示效果。
6. LED环保照明系统：美观、节能、耐用。
7. 品牌私人订制LOGO及颜色：突显品牌形象、与众不同。
8. 轮子底脚双配置：方便移动与位置固定。

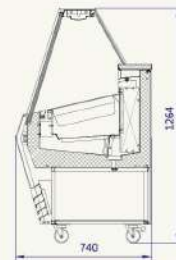

PANS MODEL / 份数盘			6	7	9
<small>PANS 2.1L SIZE:320*178*150mm GN 1/3      PANS 4.3L SIZE:320*178*150mm GN 1/3      PANS 6L SIZE:360*182*125mm GN 1/3</small>			6	7	9

MODEL 型号	Dimensions: LxWxH (mm) 尺寸:长*宽*高 (mm)	Weight(net)/ 净重/毛重 (Kg)	Voltage V/ph/Hz 电源 V/ph/Hz	Input power (W) 输入功率 (W)
6	1290*740*1264	135/152	220-240/1/50	696
7	1466*740*1264	160/180	220-240/1/50	850
9	1818*740*1264	200/225	220-240/1/50	880

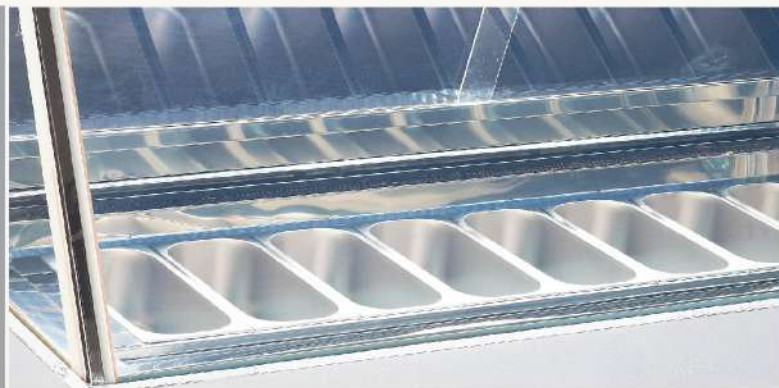



- Ventilated 风冷
- Auto. Defrosting 自动化霜
- Refrigerant R404A 制冷剂 R404A
- Temperature 工作温度 16--18°C
- Climatic class °C/RH% 环境温度/湿度 30/75

1. Hermetic compressor: High refrigerating capacity, low consumption and low noise.
2. Automatic inversion cycle defrost: quick, complete, Low temperature fluctuations.
3. Full intelligence thermostat: Italy brand Dixell thermostat, all-round monitoring temperature, safe and convenient.
4. Vacuum tempered glass s with heater: safe, defrost automatically, perfect display affection and suitable for high humidity area.
5. Straight glass, fashion and adapt for any furniture.
6. LED environmental lamp system: aesthetics, energy-saving, durability.
7. Customized logo and color: Highlight the brand image, different from others.
8. With wheels and feet: easy to move and fix.

1. 全封闭进口制冷压缩机：高效、低耗、低噪音。
2. 全自动逆循环化霜系统：迅速、干净、柜内温度波动低。
3. 全智能温控系统：意大利DIXELL超智能温控器，全天候全方位监控柜内温度、安全、省心。
4. 双层中空电加热防雾玻璃：钢化、不起雾、透视性强、耐温度高。
5. 直玻璃外观设计：时尚前卫、与吧台完美结合。
6. LED环保照明系统：美观、节能、耐用。
7. 品牌私人订制LOGO及颜色：突显品牌形象、与众不同。
8. 轮子脚垫双配置：方便移动与位置固定。

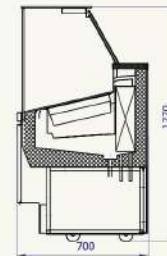

PANS MODEL / 份数盘			6	7	9
			6	7	9



MODEL 型号	Dimensions: LxWxH (mm) 尺寸:长*宽*高 (mm)	Weight(net)/ 净重/毛重 ( Kg )	(gross)	Voltage V/ph/Hz 电源 V/ph/Hz	Input power (W) 输入功率 (W)
6	1280*700*1270	135/152		220-240/1/50	696
7	1456*700*1270	160/180		220-240/1/50	850
9	1808*700*1270	200/225		220-240/1/50	880



# ICE CREAM CART 12

GELATO SHOWCASE



1. Hermetic compressor: High refrigerating capacity, low consumption and low noise.
2. Automatic inversion cycle defrost: quick, complete, Low temperature fluctuations.
3. Full intelligence thermostat: Italy brand Dixell thermostat, all-round monitoring temperature, safe and convenient.
4. Vacuum tempered glass s with heater: safe, defrost automatically, perfect display effect and suitable for high humidity area.
5. Multifunction counter : Can put cash register,yogurt machine,coffee machine,blender ,etc.
- 6.LED environmental lamp system: aesthetics, energy-saving, durability.
- 7.Customized logo and color: Highlight the brand image, different from others.
- 8.Washable pool : Can wash cups and spoon.
- 9.Storing space : Can store cups,bucket and so on.
- 10.Variety display : Can be configured with support for pans,barrels, popsicle and so on.
- 11.Save space, just less 3 square meter.

1. 全封闭进口制冷压缩机: 高效、低耗、低噪音。
2. 全自动逆循环化霜系统: 迅速、干净、柜内温度波动低。
3. 全智能温控系统: 意大利DIXELL超智能温控器, 全天候全方位监控柜内温度、安全、省心。
4. 双层中空电加热防雾玻璃: 钢化、不起雾、透视性强、耐湿度高。
5. 多功能吧台: 可放收银机、酸奶机、咖啡机、果汁机等。
- 6.LED环保照明系统: 美观、节能、耐用。
- 7.品牌私人订制LOGO及颜色: 突显品牌形象、与众不同。
- 8.清洗水池: 清洗杯子、勺子等。
- 9.储物空间: 可存罐纸杯、小桶等物件。
- 10.多样化展示: 可放置盆装、圆桶冰棒、手工雪糕等等。
- 11.节约空间, 占地不足三立方米。

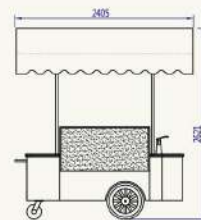

# IC CART 12



PANS MODEL / 切数盘	12
 PANS 12, SIZE: 217*100 (mm)	12
 PANS 9, SIZE: 217*100 (mm)	9
 PANS 9, SIZE: 217*100 (mm)	9

MODEL 型号	Dimensions : LxWxH ( mm ) 尺寸: 长*宽*高 ( mm )	Weight(net/gross)(Kg) 净重/毛重 ( Kg )	Voltage V/ph/Hz 电压 V/ph/Hz	Input power (W) 输入功率 (W)
12	2405*1355*2621	347/415	220-240/1/50	1300



# ICE CREAM CART 10

GELATO SHOWCASE



1. Hermetic compressor: High refrigerating capacity, low consumption and low noise.
2. Automatic inversion cycle defrost: quick, complete, Low temperature fluctuations.
3. Full intelligence thermostat: Italy brand Dixell thermostat, all-round monitoring temperature, safe and convenient.
4. Multifunction counter: Can put cash register, yogurt machine, coffee machine, blender, etc.
5. LED environmental lamp system: aesthetics, energy-saving, durability.
6. Customized logo and color: Highlight the brand image, different from others.
7. Washable pool: Can wash cups and spoon.
8. Storing space: Can store cups, bucket and so on.
9. Variety display: Can be configured with support for pans, barrels, popside and so on.
10. Save space, just less 3 square meter.

1. 全封闭进口制冷剂压缩机: 高效、低耗、低噪音。
2. 全自动逆循环化霜系统: 迅速、干净、柜内温度波动低。
3. 全智能温控系统: 意大利DIXELL超智能温控器, 全天候全方位监控柜内温度, 安全、省心。
4. 多功能吧台: 可放置收银机、酸奶机、果汁机等。
5. LED环保照明系统: 美观、节能、耐用。
6. 品牌私人订制LOGO及颜色: 突显品牌形象、与众不同。
7. 清洗水池: 清洗杯子、勺子等。
8. 储物空间: 可存捧纸杯、小桶等物料。
9. 多样化展示: 可放置盆装、圆锥冰棒、手工雪糕等等。
10. 节约空间, 占地不足三立方米。

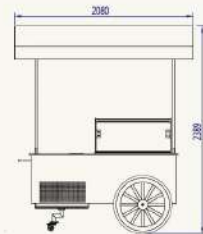

# IC CART 10



PANS MODEL / 份数盘	10
 PANS 2L SIZE:280*140*100mm GN 1/4	10
 PANS 2L SIZE:280*140*100mm GN 1/4	
 PANS 3L SIZE:320*170*100mm GN 1/3	7
 PANS 4L SIZE:320*170*100mm GN 1/3	
 PANS 5L SIZE:360*140*120mm GN 1/3	

MODEL 型号	Dimensions: LxWxH (mm) 尺寸: 长*宽*高 (mm)	Weight(net/gross)(Kg) 净重/毛重 (Kg)	Voltage V/ph/Hz 电压 V/ph/Hz	Input power (W) 输入功率 (W)
10	2080*1014*2389	347/415	220-240/1/50	625



- Ventilated 风冷 
- Refrigerant R404A 制冷剂 R404A 
- Temperature 工作温度 -16~-18℃ 
- Climate class C/RH% 环境温度/湿度 30/60 

1. Hermetic compressor: High refrigerating capacity, low consumption and low noise.
2. Automatic inversion cycle defrost: quick, complete, Low temperature fluctuations.
3. Full intelligence thermostat: Italy brand Dixell thermostat, all-round monitoring temperature, safe and convenient.
4. Vacuum tempered glass s with heater: safe, defrost automatically, perfect display affection and suitable for high humidity area
- 5.LED environmental lamp system: aesthetics, energy-saving, durability.
- 6.Glass door automatic close.
- 7.Ice cream in cups or ice cream sticker can be stored and displayed.
- 8.Fresh-keeping refrigerator is option, and model name is CUBE 100TN

1. 全封闭进口制冷压缩机组：高效、低耗、低噪音。
2. 全自动逆循环化霜系统：迅速、干净、柜内温度波动低。
3. 全智能温控系统：意大利DIXELL超智能温控器，全天候全方位监控柜内温度。安全、省心。
4. 三层中空电加热防雾玻璃：钢化、不起雾、透光度强、耐湿度高。
- 5.LED环保照明系统：美观、节能、耐用。
- 6.自动回门玻璃门。
- 7.可根据要求摆放杯装冰淇淋或者3D雪糕。
- 8.此款设备也可做冷藏款，具体型号为CUBE 100TN

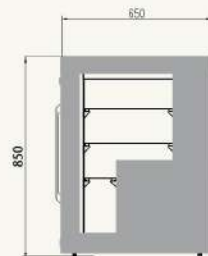

# CUBE

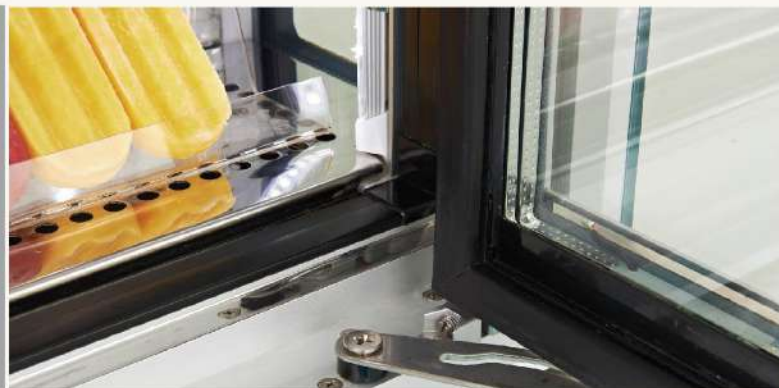

MODEL 型号	Dimensions : LxWxH (mm) 尺寸:长*宽*高 (mm)	Weight(net / gross)(Kg) 净重/毛重 (Kg)	Voltage V/ph/Hz 电源 V/ph/Hz	Input power (W) 输入功率 (W)
100BT	650*650*850	85/110	220/1/50	800



- Static 直冷
- Auto. Defrosting 自动化霜
- Refrigerant R404A 制冷剂 R404A
- Opening Glass 玻璃开启方式
- Temperature 工作温度 -16~-18°C
- Climatic class°C/RH% 环境温度/湿度 30/60

1. Hermetic compressor: High refrigerating capacity, low consumption and low noise.
2. Full intelligence thermostat: Italy brand Dixell thermostat, all-round monitoring temperature, safe and convenient.
3. Vacuum tempered glass with heater: safe, defrost automatically, perfect display affection and suitable for high humidity area.
4. The ice cream display on tabletop, save space and can be suitable for any shop.
5. Changeable configuration, stent for different ice cream pans and sticker holder are optional.
6. LED environmental lamp system: aesthetics, energy-saving, durability.
7. Two kind of glass door opening, from front side or from back side. And slow descent function offers technology feeling to operator.



G3-SS

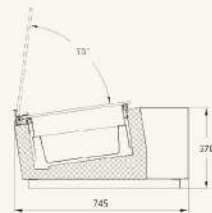

G3-ST

1. 全封闭进口制冷压缩机：高效、低耗、低噪音。
2. 全智能温控系统：意大利DIXELL超智能温控器，全天候全方位监控柜内温度，安全、省心。
3. 双层中空电加热防雾玻璃：钢化、不起雾、透视度高、耐温度高。
4. 台上型冰淇淋产品展示柜，体积小，节约空间，适用场地灵活。
5. 内部配置多变，适应多数盆装冰淇淋，可定制份数盘大小，亦可更换为雪糕配置。
6. LED环保照明系统：美观、节能、耐用。
7. 玻璃门前、后两种开启方式，并设计缓降功能，为用户体验增添科技感。

G3



MODEL 型号	Dimensions : LxWxH ( mm ) 尺寸：长*宽*高 ( mm )	Weight(net / gross)(Kg) 净重/毛重 ( Kg )	Voltage V/ph/Hz 电源 V/ph/Hz	Input power(W) 输入功率(W)
G3-SS	671*745*370	50/58	220-240/1/50	500
G3-ST	672*745*370	50/58	220-240/1/50	500





- Ventilated  
风冷
- Refrigerant R404A  
制冷剂 R404A
- Opening Glass  
开门方式
- Temperature  
工作温度 +2~+8°C
- Climatic class C/RH%  
环境温度/湿度 30/60

1. Hermetic compressor: High refrigerating capacity, low consumption and low noise.
2. Vacuum tempered glass s with heater: safe, defrost automatically, perfect display affection and suitable for high humidity area.
3. Automatic sliding doors can be close themselves.
4. The same series can has any combination with other OASL.
5. Glass can be assembly and disassembled easily. Showcase can be packaged separately, save your transport cost.
6. LED environmental lamp system: aesthetics, energy-saving, durability.
7. Customized logo and color: Highlight the brand image, different from others.
8. With wheels and feet: easy to move and fix.

1. 全封闭进口制冷压缩机组：高效、低耗、低噪音。
2. 双层中空电加热防雾玻璃：全钢化、不积雾、透视性强、耐温度高。
3. 推拉门自动回归。
4. OASI系列蛋糕柜可任意拼接组合。
5. 玻璃拆装方便，可与柜体分体包装运输降低运输成本。
6. LED环保照明系统：美观、节能、耐用。
7. 品牌私人订制LOGO及颜色：突显品牌形象、与众不同。
8. 轮子脚垫双配置：方便移动与位置固定。

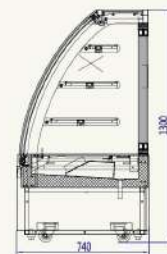

OASI



MODEL 型号	Dimensions: L*W*H (mm) 尺寸:长*宽*高 (mm)	Weight(net/gross)(Kg) 净重/毛重 (Kg)	Voltage V/ph/Hz 电源 V/ph/Hz	Input power(W) 输入功率(W)
9	900*740*1300	170/220	220-240/1/50	530
10	1000*740*1300	200/250	220-240/1/50	558
12	1200*740*1300	230/280	220-240/1/50	580
15	1500*740*1300	250/300	220-240/1/50	655
18	1800*740*1300	280/330	220-240/1/50	668
20	2000*740*1300	300/350	220-240/1/50	895



CONFECTIONERY SHOWCASE



Ventilated  
风冷

Refrigerant R404A  
制冷剂 R404A

Temperature  
工作温度 -2~+8°C

Climatic class°C/PH%  
气候温度/湿度 30/60

1. Hermetic compressor: High refrigerating capacity, low consumption and low noise.
2. Vacuum tempered glass's with heater: safe, defrost automatically, perfect display affection and suitable for high humidity area.
3. Automatic sliding doors can be close themselves.
4. The same series can have any combination with other EDEN.
5. Glass can be assembly and disassembled easily. Showcase can be packaged separately, save your transport cost.
6. LED environmental lamp system: aesthetics, energy-saving, durability.
7. Customized logo and color: Highlight the brand image, different from others.
8. With wheels and feet: easy to move and fix.

1. 全封闭进口制冷压缩机组：高效、低耗、低噪音。
2. 双层中空电加热防雾玻璃：全钢化、不起雾、透视性强、耐温度高。
3. 推拉门自动回位。
4. EDEN系列蛋糕柜可任意拼接组合。
5. 玻璃拆装方便，可与箱体分体包装运输降低运输成本。
6. LED环保照明系统：美观、节能、耐用。
7. 品牌私人订制LOGO及颜色：突显品牌形象，与众不同。
8. 轮子脚垫双配置：方便移动与位置固定。

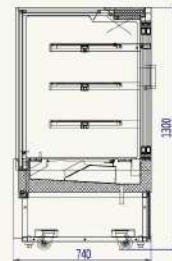

# EDEN



MODEL 型号	Dimensions: L*W*H (mm) 尺寸:长*宽*高 ( mm )	Weight(net/gross)(Kg) 净重/毛重 ( Kg )	Voltage V/ph/Hz 电压 V/ph/Hz	Input power(W) 输入功率(W)
9	900*740*1300	200/249	220-240/1/50	530
10	1000*740*1300	240/290	220-240/1/50	558
12	1200*740*1300	280/330	220-240/1/50	580
15	1500*740*1300	310/360	220-240/1/50	655
18	1800*740*1300	350/400	220-240/1/50	668
20	2000*740*1300	380/430	220-240/1/50	895

Choose the color what you like.

