

191 - 241 - 193

Classic - Steel



CARPIGANI **SOFT SERVE CONSULTING**

CARPIGANI SOFT SERVE CONSULTING consultants transform your idea into a successful business!



Fundamentals and Advantages

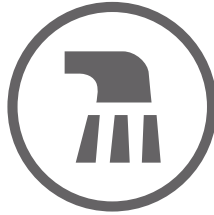



PERFORMANCE AND QUALITY

Create Soft Serve Gelato, Ice Cream, Sorbets and Frozen Yogurt. Thanks to the 193 independent cylinders, it is now possible to simultaneously serve and even mix different recipes and products.



Creamy Soft Serve Gelato

Thanks to the H-O-T system and to the type of feed system used (gravity or pump), users can choose the desired consistency of the Soft Serve, from a delicate vanilla to robust chocolate.



Soft Serve Sorbets

Choose the desired consistency of the Serve Sorbets to create robust flavors with lots of fiber or classic lemon sorbet. Thanks to the H-O-T system and to the type of feed system used (gravity or pump).



Frozen Yogurt

Choose the desired consistency of the Frozen Yogurt, to produce a classic frozen yogurt or a unique soft serve gelato yogurt. Thanks to the H-O-T system and to the type of feed system used (gravity or pump).



Custom shape Gelato



Soft Serve Core Production

Legend: ONLY Optional upon purchase Optional available even after purchase



PERFORMANCE AND QUALITY



Optional Star Door

Star Door allows the use of the new nozzles and the single-portion kit.



Optional Monoportion kit. Kit of nozzles suitable for filling small cups, cannoli and other frozen dessert monoportions.



Optional Nozzles

Customize the Soft Serve by choosing new and unique nozzles that fit your style.



Gravità - Gravity

Pompa - Pump

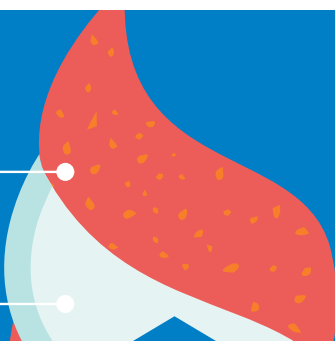

Optional Pump / Gravity kit (for 193 P models with POM beaters).

Run pump & gravity feed cylinders at the same time. Simultaneously serve traditional mixes and mixes with lots of fiber or fruit seeds.



Optional Winter Door (for 193 models).

This unique door is composed of two separate doors. Giving the user the freedom to operate one or both cylinders or even operate one cylinder while cleaning the other. The twist door is inhibited.





PERFORMANCE AND QUALITY

Hard-O-Tronic®. The electronic control system gives you the power to quickly choose the consistency of the Soft Serve in a simple manner and change it for a variety of styles of your choosing.

Optional Soft Serve Core (for 191 and 241 models). Inject syrup directly into the Soft Serve during extraction, thanks to the peristaltic pump system. The cabinet for housing the syrup and the pump can be positioned under the machine or on the left side depending on the user's installation preferences.



Choice of **MIX FEEDING SYSTEM**

Pump - Version P

Ideal for creating dry and compact Soft Serve. Pressurized steel pump with advanced thermo-plastic polymer gears. Thanks to the holes in the pump regulator, it is possible to obtain 40-80% overrun. It is possible to adjust the overrun even when the tank is full!



Gravity - Version G

Ideal for a dry and compact Soft Serve able to contain a high amount of fibers or small fruit pieces with an overrun of up to 40%. The different diameters of the holes on the feeding needle naturally dose the mixture with air. Thanks to the repeated holes both on the lower part and on the upper part of the overrun adjuster, it is possible to adjust the overrun even when the tank is full!



Legend: ONLY Optional upon purchase Optional available even after purchase



CONVENIENCE

New solutions for maximum **convenience** during use

BEATER Choice

2E-RSI High Efficiency Beater

Ideal for soft and Creamy Soft Serve. Stainless steel beater with plastic scrapers and removable shaft.



High Efficiency Beater in POM

Ideal for Frozen Yogurt, Yogurt mixes and Creamy Soft Serve with gravity fed recipes. Convenient Monobloc beater in food-grade plastic. Standard in gravity versions.



Optional Self Closing

User-friendly Self Closing levers automatically close to stop the flow of product, eliminating any waste. Automatic self closing levers are easy to assemble & disassemble. Ideal for rotating shafts.



Direct expansion cylinder

Optimized refrigeration process. Faster freezing times & more energy savings. Pre-loading operation is simple and safe, thanks to the new position of the feed hole.



Tank Agitator

Prevents product stratification during storage and improves heat exchange during pasteurization.



Adjustable dispensing speed

Adjustable delivery flow to meet all volume and speed needs.





CONVENIENCE

New solutions for maximum **convenience** during use

Versatile machine* (for 193 models).

Thanks to three different functions, it is possible to choose the side on which you want to operate. Left side only or right side only in low season, both during high productivity.

* With the Optional Winter Door.



QR CODE

Scan the **QR Code** on the front of the machine to access the most up to date equipment information: Instruction Manual, Carpi Care kit & Carpi Clean kit.



Optional Only You

Customize the front panel of the machine by choosing from the array of colors found in the dedicated catalog.



Optional Total Only You

The machine can be completely colored for a consistent look representative of the style of the product, location or brand. Choosing from the array of colors found in the dedicated catalog.



Optional Cabinet to easily position the machine inside the shop. Thanks to the cabinet, it is possible to move the machine easily and safely. Cabinet includes internal chamber to house materials.



Legend: ONLY Optional upon purchase Optional available even after purchase



SAVINGS

New **high-performance** electric gearmotors and condensers

Independent pump transmission. (P version). Extends the life of the pump and gears. Ensures flexibility with high performance.



Choice of **COOLING**

Water Cooled machine

Refrigeration system is cooled thanks to the inlet and outlet water circuit, conveniently located at the rear of the machine.



Air cooled machine

Thanks to the rear chimney, it is possible to optimize the installation space and to place the machines side by side.



SAFETY

More operational safety and **more control** during production



Ergonomic design. Reduced risk of injury, with corners even rounder where the operator works.

Black-out and water outage

After a power or water failure, if the temperature-time parameters guarantee that the mixture has not undergone any alteration, the machine resumes the program in progress. Otherwise, if the machine is self-pasteurizing, a pasteurization cycle is automatically started, warning the operator with a message on the display. In the case of the non self-pasteurizing version, the machine requires washing.



Optional **TEOREMA**

Guarantees facilitated assistance by providing on-line monitoring and diagnosis on a tablet, phone or PC wherever you are.



Button lock

For added security, the display buttons can be locked to prevent accidental errors.





HYGIENE

Easy cleaning,
guaranteed
hygiene

Scheduled start. Set the pasteurization, storage programs to automatically run at a convenient time for you, such as overnight and be fully functional the next day.

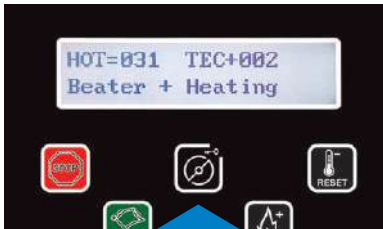

Multifunctional Cleaning Button

Possibility to activate or deactivate the pump and the beater individually or together according to cleaning needs. One of the functions is hot cleaning. By simultaneously activating the stirrer and the heating of the cylinder surface, the production grease residues are quickly dissolved.

Optional Wash kit

Water Tap is added over the tank to facilitate cleaning.

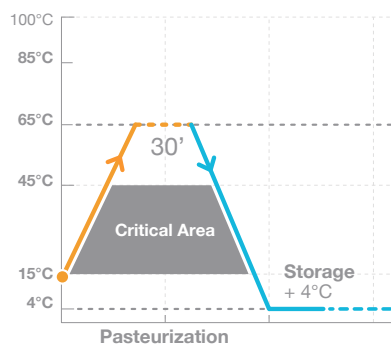

With the automatic **self-pasteurization** system you can choose when to wash the machine up to a maximum interval of 42 days. As a further guarantee of hygienic safety, if the operator does not perform the complete cleaning at the end of the set days, the machine goes into automatic block.



Removable pump shaft

Simplifies cleaning procedures, guaranteeing maximum hygiene and reliability.

Carpi Care kit



Custom kits, designed to always keep your machine hygienically perfect.

Carpi Clean kit

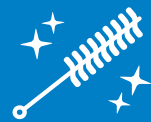

Rubber tank lid

The lid can be partially opened to fill tank without completely removing lid. In addition, on the 193 models, one can open and fill each tank separately, while preventing any mix from going in the wrong tank.



MACHINE CONFIGURATION

TANK CONFIGURATION

CHOOSE THE PRODUCT FEED SYSTEM

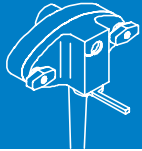

Pump



Gravity

Optional



Wash kit

BEATER & DOOR CONFIGURATION

CHOOSE THE TYPE OF BEATER



2E-RSI Beater

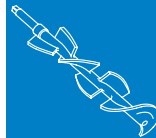

POM Beater

CHOOSE DOOR TYPE

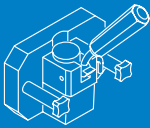

Standard Door

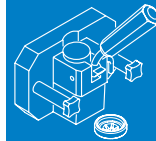

Star Door

Optional. Available for 193 models

Optional

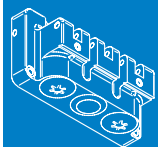

Winter Door

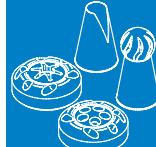

Nozzles

Optional

Optional



Self Closing Door



Monoportion kit

Legend: ONLY Optional upon purchase Optional available even after purchase

VISUAL CONFIGURATION

CUSTOMIZE THE FRONT PANEL

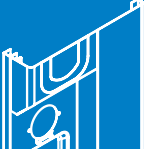

Classic Plastic Front Panel

Optional



Stainless Steel Front Panel
(Standard for 241)

Optional



Only You Personalization



Total Only You Personalization

TECHNICAL CONFIGURATION

CHOOSE THE TYPE OF CONDENSATION

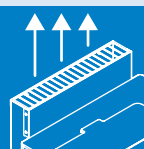

Air Cooled machine

Optional

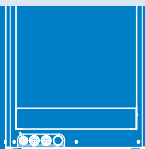

Water Cooled machine



Self-Pasteurization

CHOOSE THE TYPE OF POWER SUPPLY



Power supply Single-phase / Three-phase

ACCESSORIES CONFIGURATION

Optional. Available for 191 and 241 models



Soft Serve Core Below storage

Optional



Soft Serve Core Side Storage

Optional. Available for 193 models

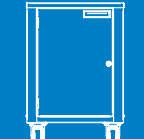

Cabinet

Optional



Pump kit / Gravity kit



Teorema

Legend:  ONLY Optional upon purchase  Optional available even after purchase

WHO WE ARE

Carpigiani Services. Always by your side! The extensive Carpigiani service network is at your disposal with a widespread assistance network that guarantees a wide coverage of the territory with over 480 authorized service centers and 1500 specialized technicians around the world, for over 70 years guaranteeing a widespread, global presence. Carpigiani Services ensures rapid and professional assistance.

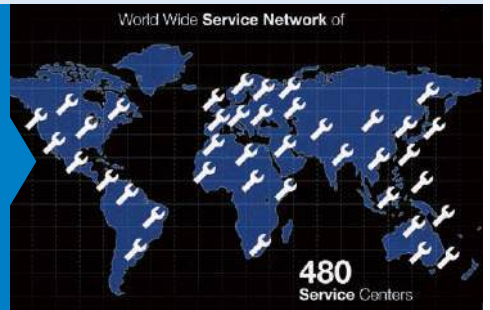

WHAT WE OFFER

Original spare parts. Carpigiani original spare parts, manufactured in compliance with national and international food safety regulations, ensure the durability of the components and extend the life of the machine. They are the only ones able to guarantee efficiency and safety. Carpigiani original spare parts are guaranteed for 1 year.



Carpi Care kit



6
MONTHS

Periodically ask your dealer **Carpi Care kit and Carpi Clean kit.** Dedicated kit of gaskets and brushes to keep each machine hygienic & clean.

Carpi Clean kit



WHAT WE OFFER

Specialized technicians. Carpigiani technicians are professionals who are always up-to-date thanks to solid and constant training courses that guarantee high levels of competence for any inspection, maintenance, cleaning and repair intervention.



Preventive maintenance. Thanks to periodic checks, entrusted to certified technicians, the machine can always work in optimal conditions, preventing any downtime.

Extended Warranty. Operate machine in complete tranquility, thanks to the Carpigiani extended warranty. In case of needs, in fact, Carpigiani technicians are able to restore machine operation with original spare parts.



Scheduled Cleaning. Possibility of entrusting the periodic cleaning of the machine to expert technicians.



Teorema. Teorema Remote Control and diagnosis system for remote monitoring of machine operation. The customer can access the machine via computer, tablet or mobile device to remotely monitor operations. Teorema also facilitates the assistance service: Carpigiani technicians are alerted on the configuration parameters as if they were operating directly on the machine.



Technical Data - Dimensions

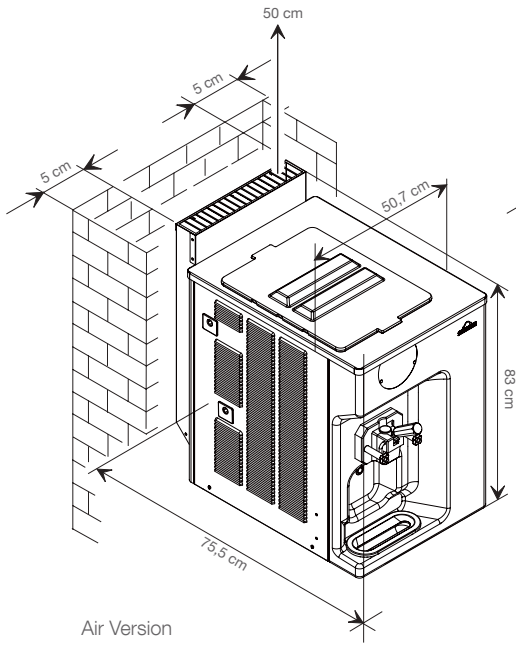

Air Version

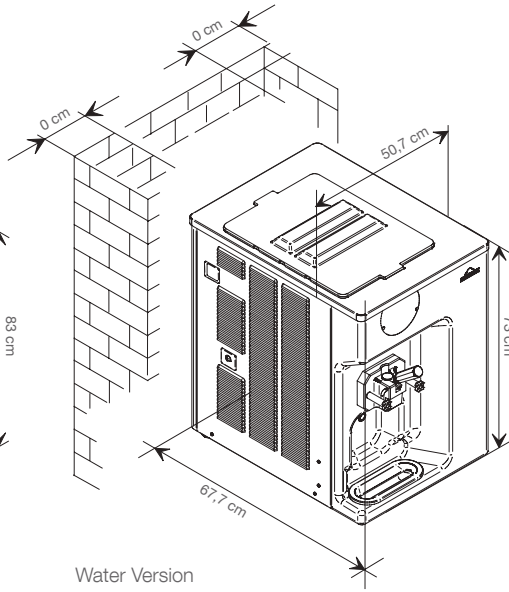

Water Version

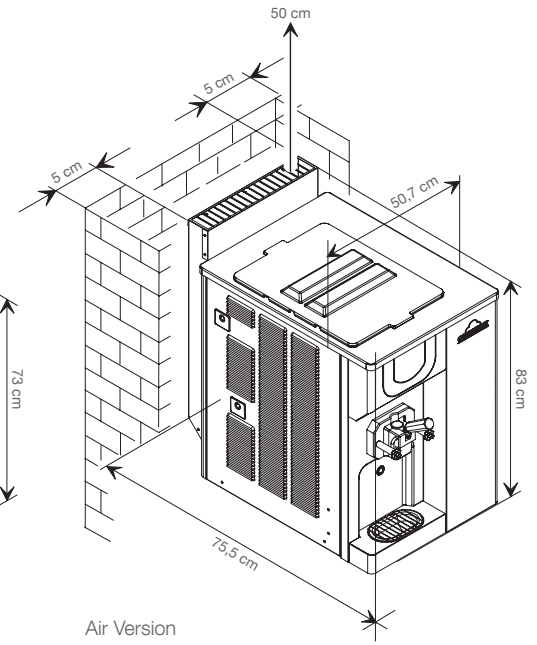

Air Version

191 CLASSIC and STEEL, 241 STEEL

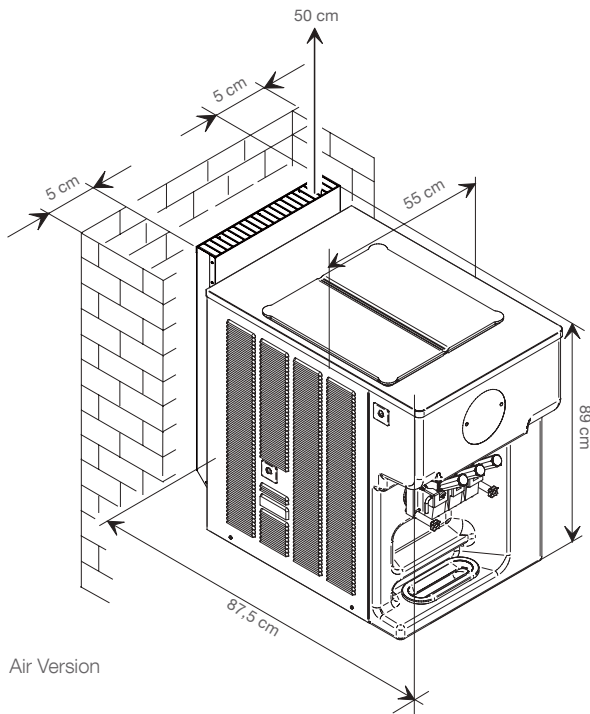

Air Version

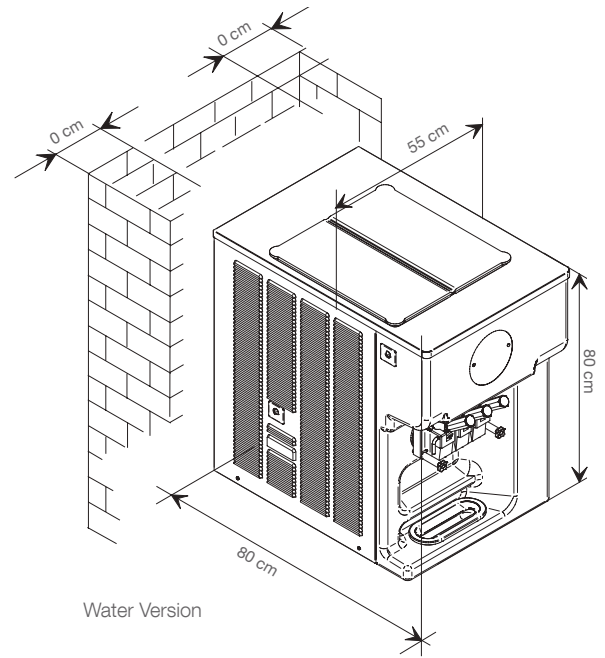

Water Version

193 CLASSIC and STEEL

191 - 241 - 193

Classic - Steel



	Flavours	Mix Delivery System	Hourly production (75gr portions)		Tank Capacity lt	Cylinder Capacity lt	Rated Power Input kW	Fuse Size A	Power Supply Volt Hz Ph	Cooling System	Refrigerant	Net Weight kg
			POM	2E-RSI								
191 Classic	P	Pump	245*	255*	12	1,75	2,4	16	230/50/1**	Air, water optional	R452***	140
191 Classic	G	Gravity	230*	-	18							130
191 Steel	P	Pump	245*	255*	12	1,75	2,4	16	230/50/1**	Air, water optional	R452***	140
191 Steel	G	Gravity	230*	-	18							130
241 Steel	P	Pump	340*	350*	12	1,75	2,9	10	400/50/3**	Air, water optional	R452***	140
241 Steel	G	Gravity	300*	-	18							130
193 Classic	P	Pump	435*	485*	12+12	1,75	4,7	16	400/50/3**	Air, water optional	R452***	210
193 Classic	G	Gravity	415*	-	18+18		4,5					190
193 Steel	P	Pump	435*	485*	12+12	1,75	4,7	16	400/50/3**	Air, water optional	R452***	210
193 Steel	G	Gravity	415*	-	18+18		4,5					190

*production capacity depends on the mix used and the room temperature **other voltages and cycles available upon request

***alternative solutions available.

191, 241 and 193 are produced by Carpigiani with Quality System UNI EN ISO 9001.

All specifications mentioned must be considered approximate; Carpigiani reserves the right to modify, without notice, all parts deemed necessary.

CARPIGIANI
 carpigiani.com



Via Emilia, 45 - 40011 Anzola dell'Emilia - BOLOGNA, Italy - T. +39 051 6505111 - info@carpigiani.it

an Ali Group Company



The Spirit of Excellence